



EN



CONTOUR CHECK

Laser measurement systems
for long products



CONTOUR CHECK

The smart way to optimize your rolling process

CONTOUR CHECK offers multiple benefits for the inline measurement of long products. Whether you're dealing with wire, rod, bar, or tubes, our system can measure relevant dimensions and detect changes in shape, rolling defects, and surface defects. Thanks to its advanced capabilities, CONTOUR CHECK can provide warnings when tolerances are exceeded, allowing you to intervene

before significant amount of scrap is produced. Moreover, the system can substantially reduce start-up times after product changes by measuring from the first moment material comes through. With CONTOUR CHECK's cutting-edge laser technology, you can considerably optimize your operations and improve your product quality.

Content	Page
Integrated solution for your rolling mill	4
Process monitoring	5
CONTOUR CHECK WIRE	6
CONTOUR CHECK BAR & TUBE	10
CONTOUR CHECK ROUND & EDGE	14
CONTOUR CHECK SHAPE	18
Model overview	24
Measuring methods	25
References	26

Fast, reliable, precise

Integrated solution for your rolling mill

CONTOUR CHECK provides all the information needed for fast and precise adjustment of rolling lines. Depending on the model, it can measure rounds, rebar, flats, squares, hexagons, or even octagons. The patented technology allows precise identification of roller misalignment, two- and one-sided over- and underfilling of the groove pass, even at a high vibration and rotatory movement of the rolled material.

Off-size conditions are immediately displayed and allow corrections during the runtime of a billet. Elimination of sample cutting and quantity reduction of billet samples reduce the ramp-up time after a size or product change. Precise determination of off-size lengths at head and tail allows crop optimization, further increasing the yield.

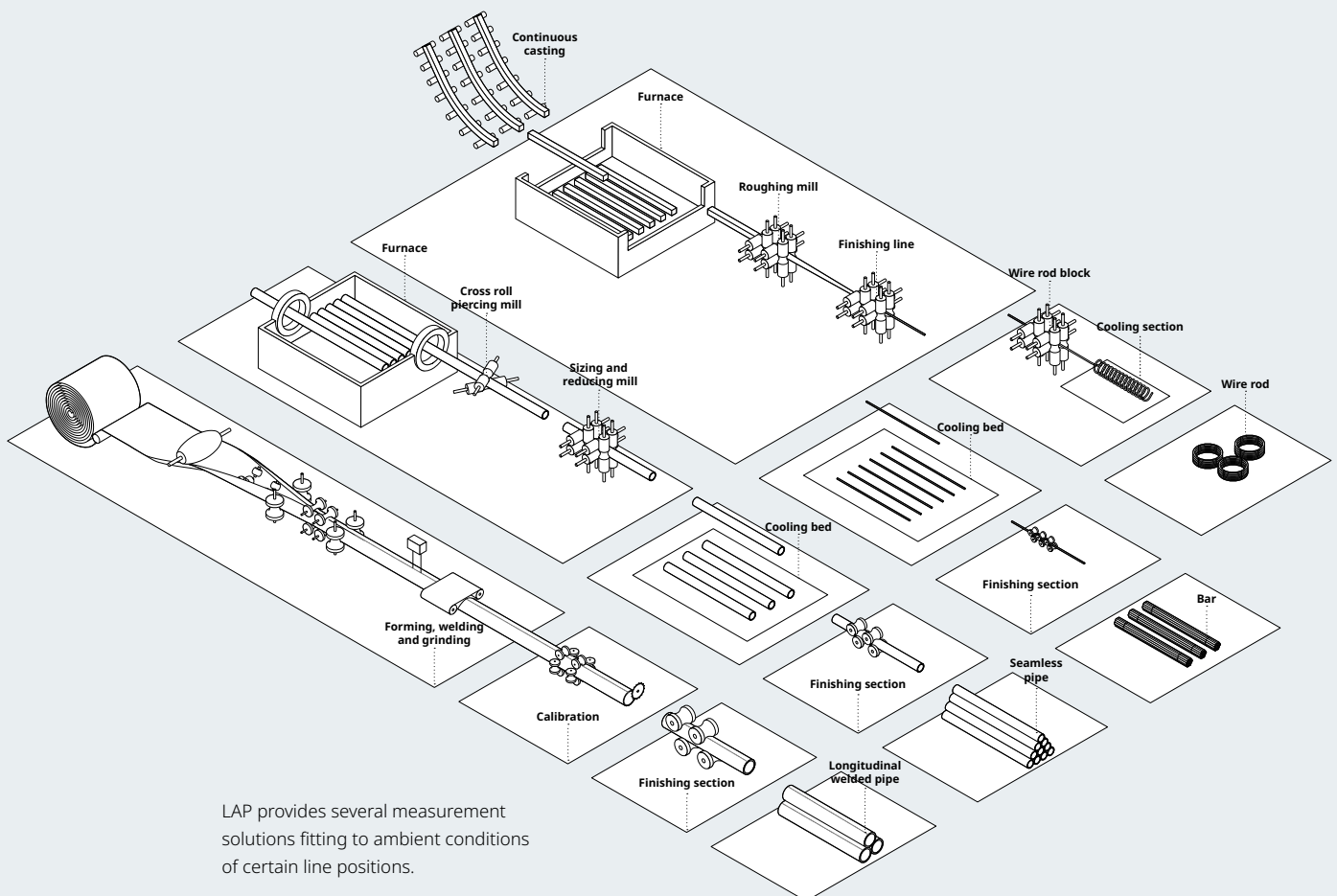

Check, detect, improve

Comprehensive process monitoring

Your customers' satisfaction depends on the quality of the products you provide. The quality depends on your control of the production process. For control, you need precise, detailed and reliable information.

CONTOUR CHECK provides this data for process control and documentation.

- Check dimensions and show trends
- Detect rolling defects and offer solutions
- Detect surface defects
- Connect several CONTOUR CHECK systems for a comprehensive process analysis

Benefits



Monitoring

CONTOUR CHECK shows you what happens in your production. You can see trends, implement corrective action and check the impact before exceeding a limit. If sudden errors occur, they are documented for later handling.



Quality

Deliver optimum quality and stand out from your competitors. Quality equals saving money, as you increase efficiency and yield, and you reduce scrap as well as customer complaints.



Documentation

All data is recorded and saved to a database. You can access to parameters and measure values for all jobs, batches, and single products.



Analysis

Use filed data for precise analysis of production parameters. Save money by using the optimum parameter set. Detect weaknesses before they have visible impact on your production.

CONTOUR CHECK
WIRE 45-1



CONTOUR CHECK
WIRE 45-2/3 C-Frame



CONTOUR CHECK WIRE

CONTOUR CHECK WIRE is a laser gauge profile measurement system that quickly and accurately quantifies the diameter for small round cross sections. In the version with 1 axis, it can precisely measure wires. The CONTOUR CHECK WIRE with 2 or 3 axes in an O-frame is even suitable for hot bars and reinforced bars.

The compact industrial design and the use of SMART CORE BASIC software optimized for monitoring rolling processes makes the WIRE gauge reliable and easy to integrate into production control systems. It is cost-effective, fast, flexible and increases accuracy, leading to quick returns on investment.

- Dimensional measurement of wires and rebars
- Measurement range of 45 mm
- Three economic housing types
- 1 axis for diameter measurement
- 2 or 3 axes for measuring the diameter and ovality
- C-shape frame for easy installation
- O-Frame shape for temperature resistance in terms of accuracy
- Dirt, humidity, and thermal protection with permanent airflow (purging air)

CONTOUR CHECK
WIRE 45-2/3 O-Frame



General

Round

Rebar

Flat

Square

Hexagonal

Octagonal

Software

Data

Products



Wire

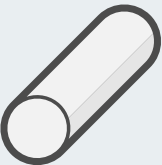

Bar

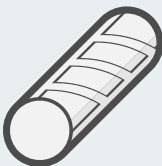

Rebar

Benefits



Cost-effective;
Quick pay off



Quick and easy
integration



For cold, warm, and hot
applications (max 1200 °C)



Small, mobile frame

CONTOUR CHECK WIRE

Technical data and software SMART CORE BASIC

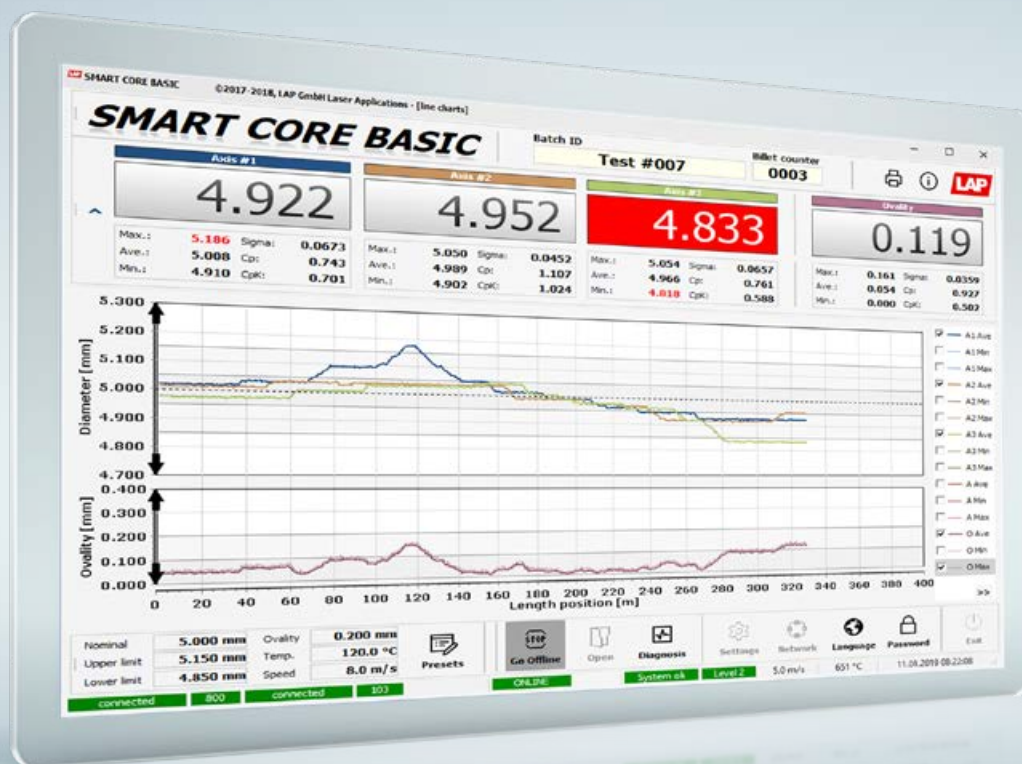

Standard view for a 3-axis round measurement with current measurement values and statistics by axis (top), line charts for diameter and ovality (middle), nominal and limit values (bottom left), and function buttons (bottom right)

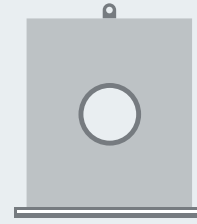
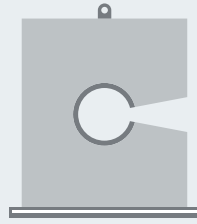



**CONTOUR CHECK
WIRE 45-1**

**CONTOUR CHECK
WIRE 45-2/3 C-Frame**

**CONTOUR CHECK
WIRE 45-2/3 O-Frame**

Measuring range [mm]	45	45	45
Accuracy (trueness) [mm]	±0,015	±0,015	±0,015
Repeatability (precision) [mm]	0,004	0,004	0,004
Material temperature [°C]	≤40	≤300	≤1200
Number of axes [pc]	1	2, 3	2, 3
Frame type	C-Shape	C-Shape	O-Shape
Frame width [mm]	190	620	650
Frame height [mm]	630	718	718
Frame depth [mm]	82	78	78
Passline height [mm]	315	358	358
Frame weight [kg]	13	53	56
Positioning system (optional)	No	Yes	Yes

Blower	No	
Air cooling unit (optional, dimensioning depends on ambient conditions)	No	
Pyrometer (optional)	No	No

Standard

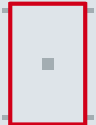

Measuring frame with sensors ■ Control panel with Ethernet gateway
 Software license SMART CORE BASIC ■ Cable between measuring frame and control panel
 Sensor parameter set ■ Blower ■ Air temperature sensor ■ Air flow monitor

Optional



Masterpiece and holder ■ Cooling unit for higher inlet air temperature
 PC-Set ■ Software add-on for rebar measurement
 Level 2 connection ■ Commissioning



CONTOUR CHECK BAR & TUBE



CONTOUR CHECK BAR & TUBE

CONTOUR CHECK BAR & TUBE is a non-contact measurement system with laser sensors that measure the diameter and ovality of mid-size round material. The profile measurement system provides all the information needed for fast and precise adjustment of rolling lines and can measure rounds and rebars. Eliminating sample cuttings reduces the ramp-up time after a size or product change, and precise determination of off-size lengths at head and tail allows crop optimization, further increasing mill yield.

The CONTOUR CHECK BAR & TUBE is available with measuring ranges of 90 mm, 120 mm, 150 mm and can be exposed to material temperatures of up to 200 °C.

- Dimensional measurement of bars
- Measures diameter and ovality
- Measurement range of 90 mm / 120 mm / 150 mm
- Maximum material temperature 200 °C
- 2 or 4 axes
- Dirt and humidity protection with permanent airflow (purging air)

Products



Wire



Bar

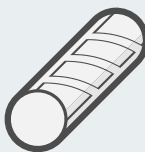

Rebar



Tube

Benefits



Specialized in bar and tube lines with a max. measurement range of 150 mm



Quick and easy installation in existing production lines



Cost-effective measurement solution for products up to 200 °C



Documented quality

CONTOUR CHECK BAR & TUBE

Technical data and software SMART CORE ADVANCED



Standard view for a 6-axis round measurement with presets (top left), cross section chart (top middle), current measurement values and statistics by axis (top right), line charts for diameter and ovality (bottom)

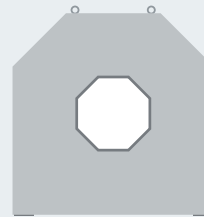
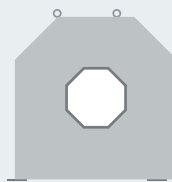
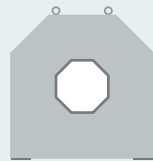

**CONTOUR CHECK
BAR & TUBE 90**

**CONTOUR CHECK
BAR & TUBE 120**

**CONTOUR CHECK
BAR & TUBE 150**

Measuring range [mm]	90	120	150
Accuracy (trueness) [mm]	±0,020	±0,025	±0,030
Repeatability (precision) [mm]	0,0045	0,005	0,008
Number of axes [pc]	2, 4	2, 4	2, 4
Frame width [mm]	1100	1580	1580
Frame height [mm]	1115	1595	1595
Frame depth [mm]	155	155	155
Passline height [mm]	565	805	805
Frame weight [kg]	200	370	390
Positioning system (optional)	Yes	Yes	Yes

Blower



Air cooling unit (optional, dimensioning depends on ambient conditions)



Pyrometer (optional)

No

No

No

Standard

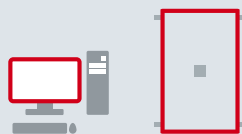

Measuring frame with sensors ■ Control panel with Ethernet gateway
Server PC with evaluation SW and data archive
Software license for 2P round ■ Cable set ■ Calibration set
Blower ■ Set of hoses

Optional

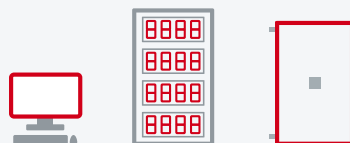

Software add-on for rebar measurement ■ Level 2 connection
Positioning system ■ Cooling unit ■ Big LED display
Industrial PC-set ■ iba interface



CONTOUR CHECK ROUND



CONTOUR CHECK EDGE

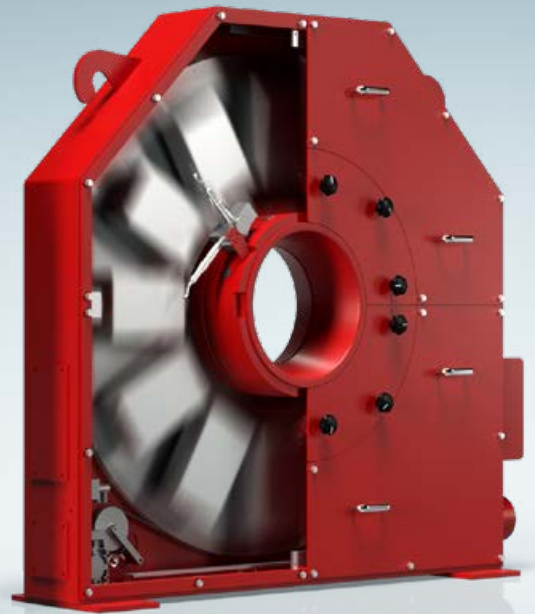

CONTOUR CHECK ROUND & EDGE

CONTOUR CHECK ROUND is the standard solution for dimensional measurement of round profiles and rebars up to 1200 °C. The versions with 3 or 6 axes can precisely measure round material produced by Y rolling stands.

CONTOUR CHECK EDGE uses a set of sensors on an oscillating baseplate. In this way, square, flat, or hexagonal profiles can also be handled. The baseplate can also move to a certain angle position. Both systems use METIS laser sensors in standard or "big diameter" configurations.

LAP provides the SMART CORE ADVANCED software to complete the solution for CONTOUR CHECK ROUND & EDGE systems.



Standard layout for one axis



"Big diameter" layout for one axis

- Slim housing, can be moved in and out of the production line on a rail
- Mechanically stress-free base plate carries sensors separated from the housing
- Thermal protection by airflow and air cooling

Products



Wire

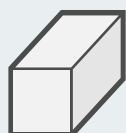

Square



Bar



Flat



Rebar

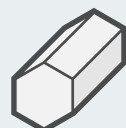

Hexagonal



Tube

Benefits



Stable data capturing & processing for products up to 1200 °C



Supervision: show deviations and errors occurring during the production process



Increased product quality













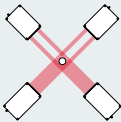

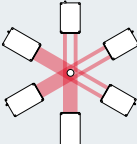

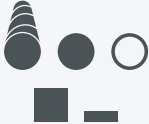

Assures minimal product changeover times

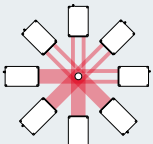
CONTOUR CHECK ROUND & EDGE

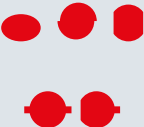
Technical data

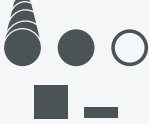
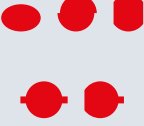
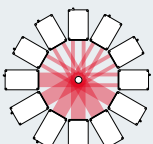

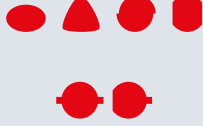
CONTOUR CHECK ROUND 45

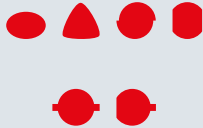
	Profiles	Visible rolling defects
 2 Axes ROUND		
 3 Axes ROUND		
 3 Axes EDGE		
 4 Axes ROUND		
 4 Axes EDGE		
 6 Axes ROUND		
 6 Axes EDGE		

Measuring range [mm]	45
Accuracy (trueness) [mm]	±0,015
Repeatability (precision) [mm]	0,004
Number of axes [pc]	2, 3, 4, 6
Frame width [mm]	860
Frame height [mm]	940
Frame depth [mm]	81
Passline height [mm]	450
Frame weight [kg]	125
Positioning system (optional)	Yes

Blower	
--------	---

Air cooling unit (optional, dimensioning depends on ambient conditions)	
---	---

Pyrometer (optional)	Yes
----------------------	-----

Standard

Optional



CONTOUR CHECK ROUND 90

CONTOUR CHECK EDGE 90

90

±0,020

0,0045

2, 3, 4, 6

1240

1170

253

570

580

Yes

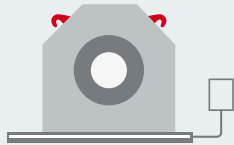

CONTOUR CHECK ROUND 120/150

CONTOUR CHECK EDGE 120/150

120/150

±0,025/±0,030

0,005/0,008

2, 3, 4, 6

1720

1685

253

835

930

Yes

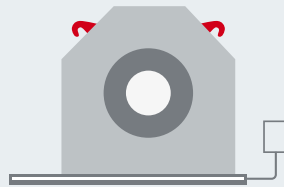

CONTOUR CHECK ROUND 180/230

CONTOUR CHECK EDGE 180/230

180/230

±0,035/±0,045

0,010/0,012

2, 3, 4, 6

2250

2215

253

1100

1500

Yes

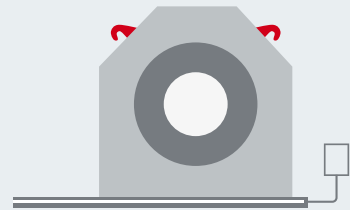

CONTOUR CHECK ROUND 500

CONTOUR CHECK EDGE 500

500

±0,090

0,025

2, 3, 4

2550

2515

253

1250

1900

Yes

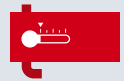

Yes

Yes

Yes

Yes

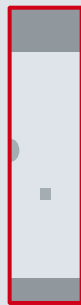

Server PC with evaluation SW and data archive & control cabinet
 Measuring rate: 800 Hz ■ Temperature and air flow monitoring in frame
 Software license for 2P round ■ Cable set ■ Calibration set ■ Blower ■ Set of hoses

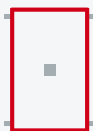

Different options for control cabinet, control panel, and visualization devices ■ Software add-ons for different profiles
 Database extension ■ Cooling unit ■ Different positioning systems ■ Industrial PC-set
 Level 2 interface ■ iba interface ■ Multi-client application ■ Speed monitoring

Software add-on for 3-roll technology ■ Software add-on for rebar measurement
 Different integrated pyrometer sets ■ Uninterruptible power supply ■ Big LED display or big monitor
 Air conditioning unit for cabinet ■ Measuring rate 1600 Hz or 2000 Hz



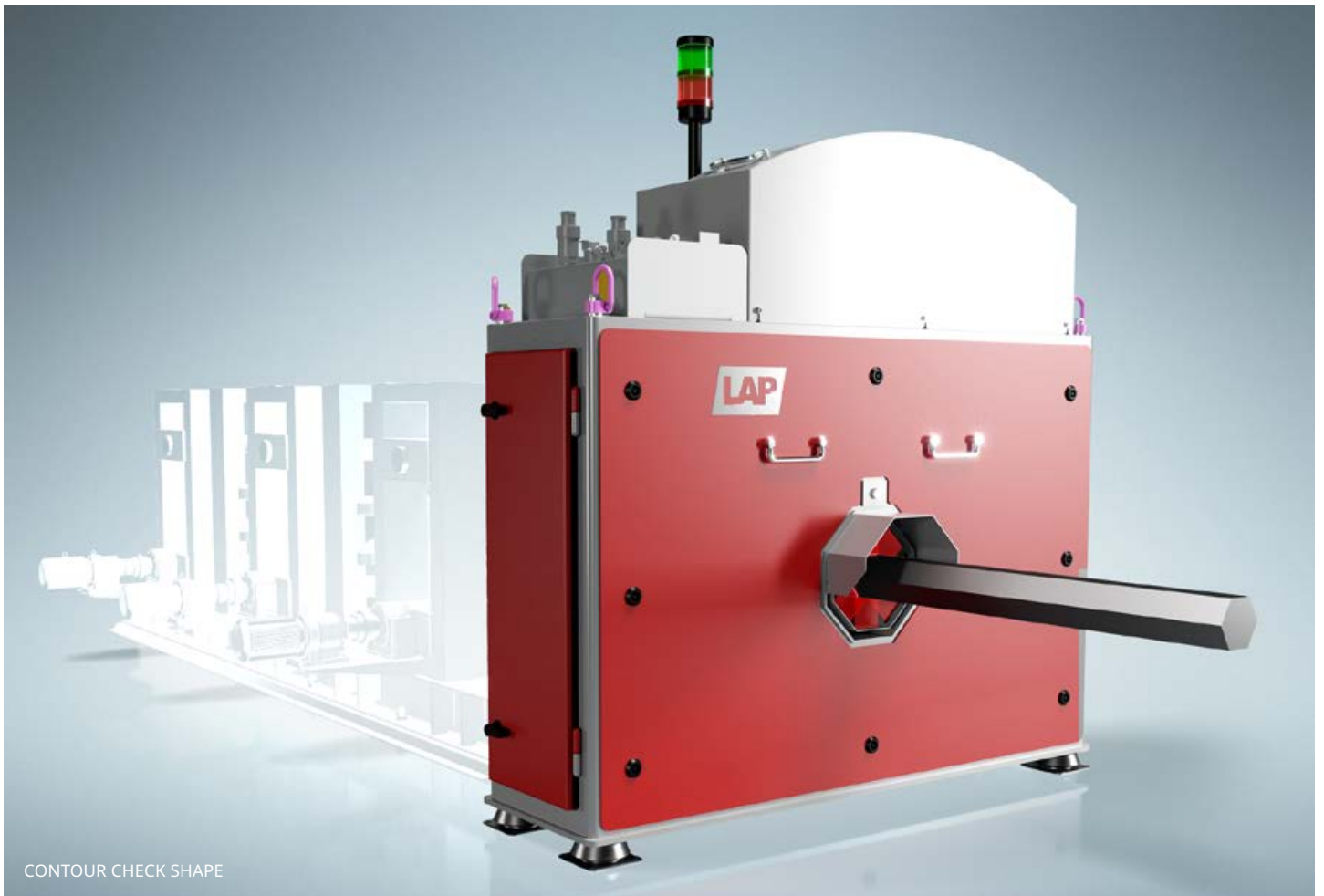

CONTOUR CHECK SHAPE

CONTOUR CHECK SHAPE

CONTOUR CHECK SHAPE is a laser-based measurement system for long products. The purpose of CONTOUR CHECK SHAPE is to control all dimensions and detect rolling defects during the production process of long products. The system can be applied for inline measurement of long products before and after a rolling stand and for both hot and cold material. The revised rebar software add-on offers even more measurement details for ribbed steel. The cameras are protected by 4 measures: heat shield, air purging, airflow around the sensors, and water-cooling. The laser lines are blue, violet, or green for optimal visibility on glowing surfaces.



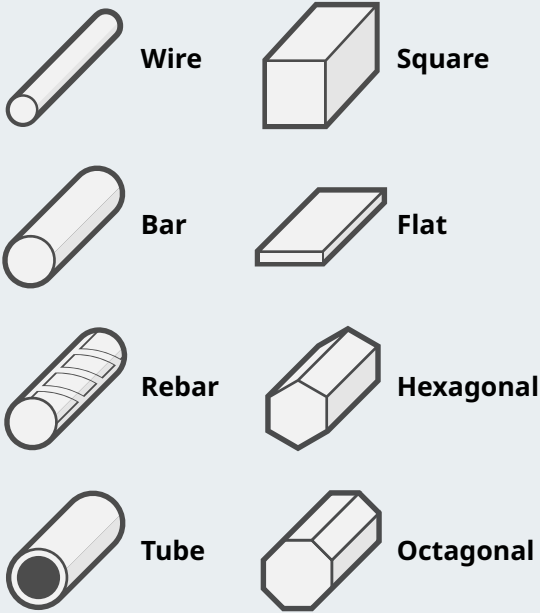

The rugged, robust design of CONTOUR CHECK SHAPE is based on more than 30 years of experience in supplying systems for rolling mills.

- Standardized gauge with no moving parts
- Detection of geometrical deviations of nominal profile, rolling, and surface defects
- Temperature stabilized setup
- Supporting various profile types
- Closed thermal design for extreme conditions
- Standardized setup for measuring ranges from 50 mm to 500 mm, bigger measuring ranges upon request
- High accuracy and simple calibration
- Intuitive software for visualization and documentation

Products



Benefits

-  100 % process monitoring
-  Applicable to multiple contours with a max. temperature of 1200 °C
-  Scrap reduction/instant recognition of anomalies
-  Automatic detection of important rolling and surface defects

Surface defect detection

SMART CORE PRO software provides users of CONTOUR CHECK SHAPE systems with intelligently configured visualization of geometrical data that can be applied directly in the process line and in the data structures of an Industry 4.0 production environment. SMART CORE PRO shows profile deviations and surface defects at a glance.

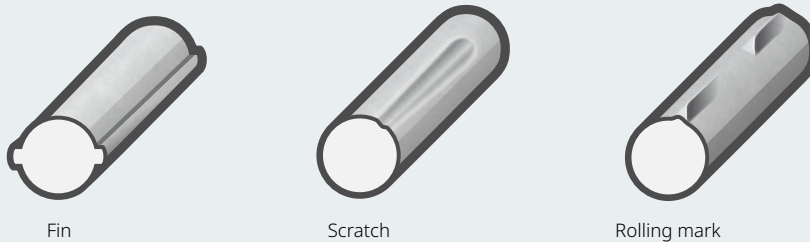

CONTOUR CHECK SHAPE

Technical data



CONTOUR CHECK SHAPE 50

Measuring range [mm]	50
Accuracy (trueness) [mm]	±0,015
Repeatability (precision) [mm]	0,003
Number of cameras [pc]	4
Frame width [mm]	1270
Frame height [mm]	1280
Frame depth [mm]	370
Passline height [mm]	450
Frame weight [kg]	355
Positioning system (optional)	Yes
Blower	
Air and water cooling unit (dimensioning depends on ambient conditions)	
Pyrometer (optional)	Yes
Standard	
Optional	
Detectable rolling defects	

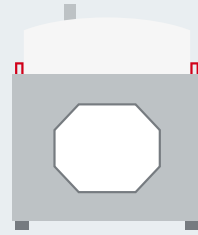
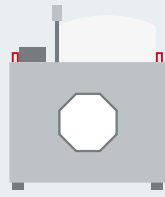
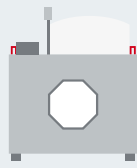
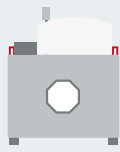

**CONTOUR CHECK
SHAPE 100**

**CONTOUR CHECK
SHAPE 150**

**CONTOUR CHECK
SHAPE 250**

**CONTOUR CHECK
SHAPE 500**

100	150	250	500
±0,025	±0,040	±0,065	±0,100
0,006	0,009	0,015	0,030
4	4	4	4
1270	1470	1770	2400
1480	1680	2170	2590
470	550	640	745
540	640	780	890
435	585	895	1370
Yes	Yes	Yes	Yes

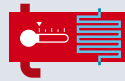
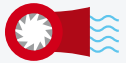

Yes Yes Yes Yes

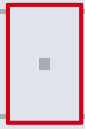
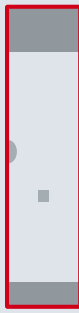

Control cabinet with HMI ■ Control panel including controller ■ Several software licenses
Several temperature and air flow sensors ■ Measuring rate up to 2000Hz

Cable set ■ Calibration set ■ Blower ■ Set of hoses ■ Water conditioning unit ■ Fluid connection set



Multi-client application ■ Different integrated pyrometer sets ■ Speed monitoring ■ Air-condition for cabinet
Software add-on for 3-roll technology ■ Software add-on for rebar measurement
Uninterruptable power supply ■ Big LED display or big monitor ■ iba connection ■ Level-2 interface
Software add-ons for different profiles ■ Software add-on for surface defect detection
Different positioning systems ■ Industrial PC-set ■ Software add-ons for different profiles



General

Round

Rebar

Flat

Square

Hexagonal

Octagonal

Software

Data

CONTOUR CHECK SHAPE

SMART CORE PRO

software

The functions and display of SMART CORE PRO are optimized for monitoring rolling processes. The software HMI offers the possibility to show line graphs, cross section chart, numerical values, visualization of rolling defects, tables, and much more. Besides standard displays, customers can

modify or create new screens displays to their needs. The software offers the unique functionality to automatically rotate the wire or rod to mill orientation to directly measure the real rolling defects.

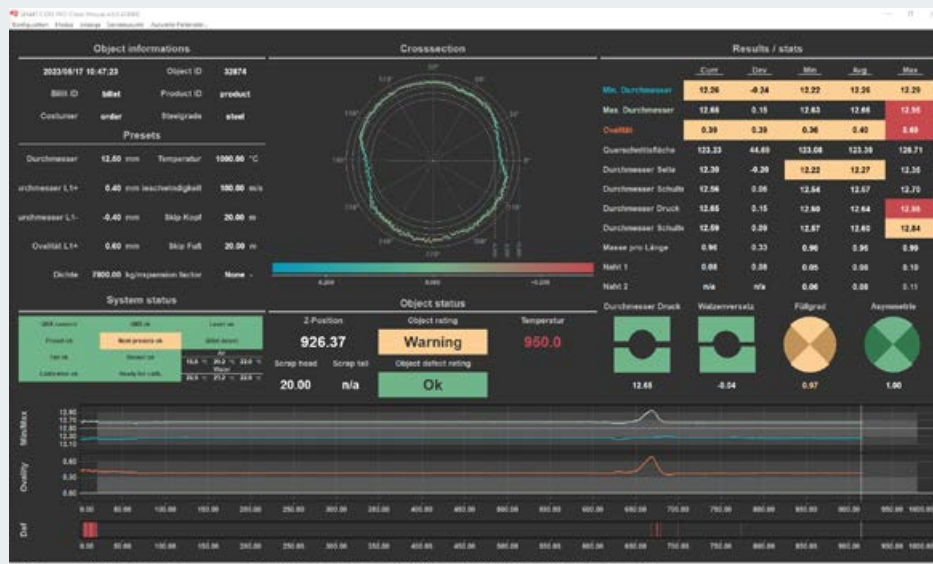

First screen display:
Round profile with under-filling and a big defect, produced by a H/V stand

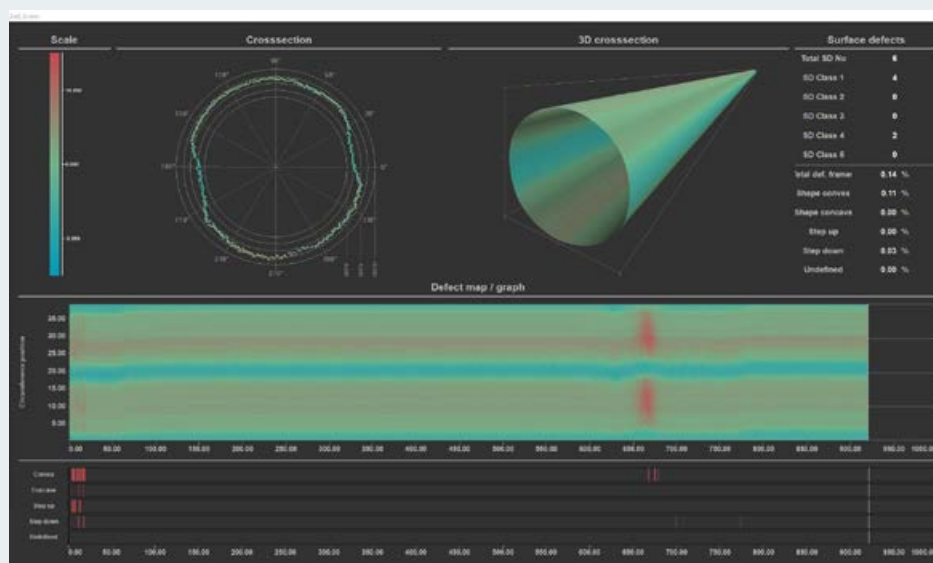

Second screen display:
3D cross section chart and defect map

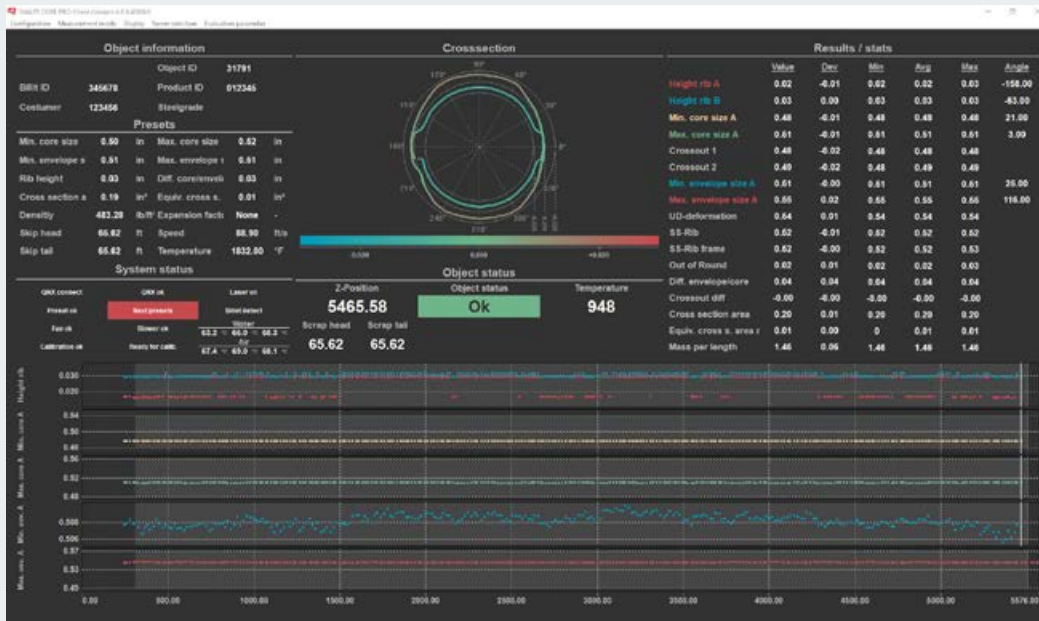

Rebar: i.a. core dimensions, rib height, diameter on certain positions, and mass per length are measured

Industry 4.0 ready

- SMART CORE PRO finds rolling defects on the surface over the complete shape
- Profile cross section, numerical values, production history, pass/fail information and production details
- Visualization can be configured to specific user requirements
- Database for long-term storage of relevant data
- Multi-client capable even on Windows tablets
- Interfaces to process data acquisition and analysis systems such as iba-interface
- Up to 4 systems can be connected to and evaluated by one server
- Connection via level-2 interface for data exchange with the control system (as well as all other measuring frames from LAP)

CONTOUR CHECK

Model overview

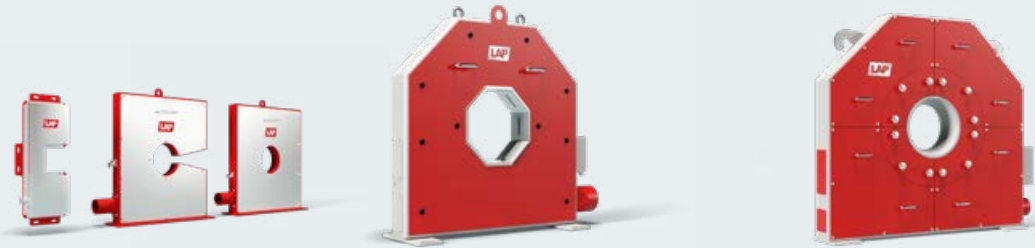

**CONTOUR CHECK
WIRE**

**CONTOUR CHECK
BAR & TUBE**

**CONTOUR CHECK
ROUND**

**CONTOUR CHECK
EDGE**

Round



Diameter, ovality



Diameter, ovality



Diameter, ovality



Diameter, ovality

Square



Height, width,
diagonal length

Flat



Height, width,
diagonal length

Hexagonal



Distance between
corners,
width across flats

Octagonal

Rebar

Yes

Yes

Yes

**Material
temperature**

Up to 1200 °C

200 °C

1200 °C

**Rolling
defects**

Not detected

Detection of irregularities,
interpretation
required

Detection of irregularities, interpretation required

**Defects on
surface**

Not detected

Not detected

Not detected

**Measurement
scope**

Outer dimension
(Shadowing)

Outer dimension
(Shadowing)

Outer dimension
(Shadowing)



CONTOUR CHECK SHAPE

● Diameter, ovality, groove pass related diameters

■ Height, width, side length, diagonal length, corner radius, corner angle, convexity and concavity of sides, parallelism of sides

■ Height, width, side length, diagonal length, corner radius, corner angle, convexity and concavity of sides, parallelism of sides

⬡ Side relations, side length, distance between corners, width across flats, corner radius, corner angle, convexity and concavity of sides, parallelism of sides

⬡ Side relations, side length, distance between corners, width across flats, corner radius, corner angle, convexity and concavity of sides, parallelism of sides

Yes

1200 °C

Detection and identification

Detected within specified limits

Surface profile
(Laser Light Section)

Measuring methods

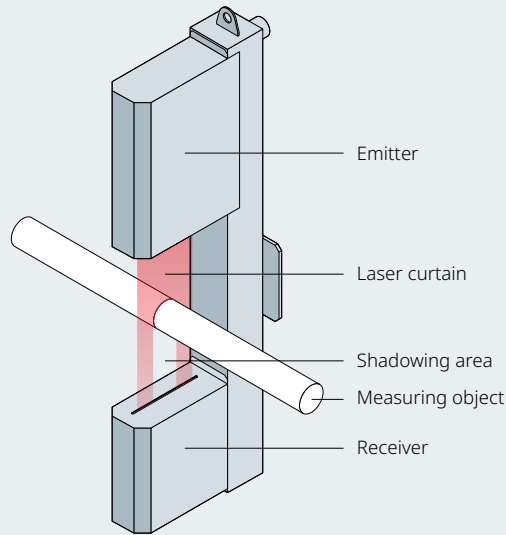

Shadowing method

One sensor consists of an emitter and a receiver in separate housings. In the emitter, a laser beam hits a rotating polygon mirror. The deflected beam is converted into a beam that periodically runs through the measuring area, building a virtual light band. The parallel moving beam in the receiver is focused on a light-sensitive diode. Any object within the measuring field partially shadows the receiver. The time interval of shadowing precisely determines the dimension of the object. LAP uses METIS laser sensor of our own design and production.

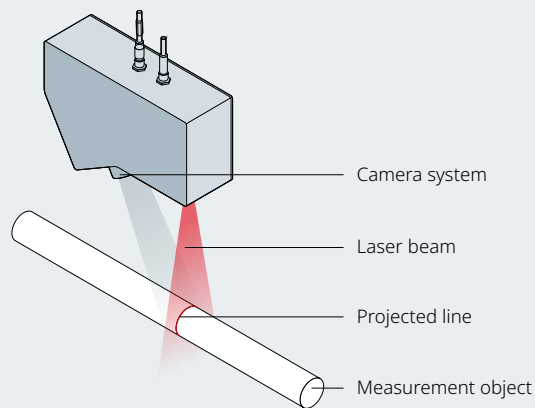

Laser light section method

The sensor contains a line laser, a high-dynamic camera, and electronics for processing the camera signals. The laser projects a straight line perpendicular to the surface to be measured. The camera is fixed at a certain angle to the laser line. Any deformation of the surface causes a deformation of the laser line from the camera's angle of view. Using the basic calibration as a reference, the sensor calculates the dimensional values. LAP designs and manufactures laser light section sensors using its own laser technology and high-end industry cameras that best fit the customer's requirements.

References

LAP's laser measurement systems help leading steel manufacturers worldwide to optimize their production processes and improve quality. Our systems enable the measurement of crucial geometrical values, such as height, width, length, diameter, and ovality of steel products, whether they are intended for hot or cold applications. Here you will find an excerpt from the reference list of our worldwide customers focusing on the main regions.

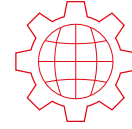

500 +
Installed systems

Europe

- CONTOUR CHECK SHAPE 50 for measuring diameter and ovality as well as detecting surface defects of wire in a wire rod mill
- CONTOUR CHECK SHAPE 250+50 for measuring outer dimensions, corner radius, and specific welding parameters, as well as detecting surface defects of square and flat profiles in a tube mill
- CONTOUR CHECK ROUND 120-4 for measuring the diameter and ovality of bar, rod, and rebar in a bar mill

USA and Canada

- CONTOUR CHECK ROUND 90-6 for measuring the diameter and ovality of wire in a wire rod mill
- CONTOUR CHECK SHAPE 50 for measuring groove pass-related diameters of wire in a wire rod mill
- CONTOUR CHECK ROUND 45-6 for measuring the diameter, ovality, and cross-section area of wire in a wire rod mill

China

- CONTOUR CHECK SHAPE 150+60 for measuring cross-sectional dimensions of round and special flat profiles in a bar mill
- CONTOUR CHECK SHAPE 100 for measuring the diameter and ovality, as well as detecting surface defects of bar and rod in a bar mill
- CONTOUR CHECK ROUND 90-4 for measuring the diameter, ovality, and cross-sectional area of wire in a wire rod mill

Japan

- CONTOUR CHECK ROUND 150-4 for measuring the diameter and ovality of bar, rod, and rebar in a Y-stand bar mill
- CONTOUR CHECK SHAPE 500 for measuring the cross-section of round and flat profiles
- CONTOUR CHECK ROUND 150-6 for measuring the diameter and ovality of round profiles in a bar mill

South Korea

- CONTOUR CHECK EDGE 90-4 for measuring the diameter and ovality of wire in a wire rod mill

About us

LAP is one of the world's leading suppliers of systems that increase quality and efficiency through laser projection, laser measurement, and other processes. Every year, LAP supplies 15,000 units to customers in industries as diverse as radiation therapy, steel production, and composite processing. LAP employs 300 people at locations in Europe, America, and Asia.



90+
Partners

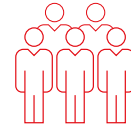

300
Employees



7
Locations



Quality

We work to uniform standards and with certified processes. For us, "Made in Germany" means the highest precision in manufacturing and quality inspection of each device. For our customers, this means planning and process certainty.

All our worldwide locations use a quality management system according to EN ISO 13485 or EN ISO 9001. Our products have all the necessary approvals and registrations almost everywhere in the world.



Service

We ensure the maximum availability of your equipment so you can concentrate on your core process. Wherever you need us, our certified service technicians are quickly on site in any time zone. We support you from installation and commissioning, through user training, up to maintenance, repair, or unit replacement.

Our efficient logistics ensure the fast availability of spare parts worldwide. For technical questions and support, our helpdesk is at your disposal by telephone, via e-mail, or remote diagnosis.



More about our
global QM system



Contact us!
info@lap-laser.com

Contact us!

P +49 4131 95 11-95

E info@lap-laser.com

in LAP Laser

▶ [laplaser](#)

LAP Measurement Technology GmbH

Zeppelinstr. 23

21337 Lüneburg

Germany

LAP GmbH Laser Applikationen, Germany / LAP Measurement Technology GmbH, Germany / LAP FRANCE SAS, France
LAP Laser Applications Asia Pacific Pte. Ltd., Singapore / LAP Laser Applications China Co. Ltd., China / LAP of America Laser Applications,
L.L.C., USA / LifeLine Software, Inc., USA / Our worldwide partners: Argentina / Australia / Brazil / Bulgaria / Canada / Chile / Colombia / Croatia
Czech Republic / Dominican Republic / Egypt / Finland / Greece / Hungary / India / Indonesia / Italy / Japan / Jordan / Kuwait / Latvia / Lebanon
Lithuania / Malaysia / Mali / Malta / Mexico / Netherlands / Norway / Oman / Philippines / Poland / Portugal / Qatar / Romania / Saudi Arabia
Slovakia / Slovenia / South Africa / South Korea / Spain / Sweden / Switzerland / Taiwan, China / Thailand / Turkey / United Arab Emirates
United Kingdom / Venezuela / Vietnam / Zambia

LAP is a registered trademark of the LAP Group in several countries worldwide including the USA and EU. Designations of other companies and products are used for identification purposes only (e.g. to inform about the compatibility). These names can be trademarks or registered trademarks which belong to their respective owners. The use of any of these trademarks by third parties may infringe the rights of the respective owner.

www.lap-laser.com/contour-check